

Catchbox Plus User Manual



Copyright 2024 Catchbox SIA version 1.0



Hub Receiver



Cube Cover

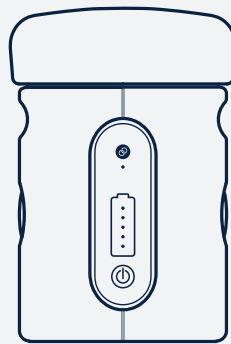

Cube Transmitter



Clip Transmitter



Stick

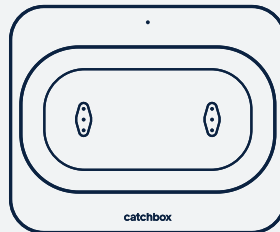

Single and dual charging docks
for Clip and Stick



Cube Charging Base



Dock bracket

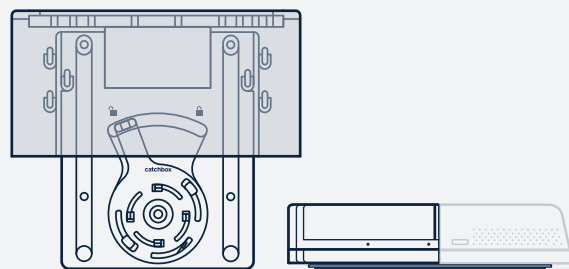

Hub Mounting Kit

Table of Contents

1. Safety Instructions	4
1.1. Notice	4
1.2. Warning	4
1.2.1 Throwing the Cube mic	4
1.2.1 Proper Use	4
1.2.1 Magnet precautions	4
1.2. Caution	5
2. System Products	5
2.1. Overview	5
3. Hub Receiver with built-in DSP	6
3.1 Connectivity Options	6
3.2 Hub DSP capabilities	6
3.2.1 Automixer	6
3.2.2 Auto EQ and Auto Level	6
3.2.3 Echo Canceller and Howling Limiter	6
3.2.4 Feedback Suppression	6
3.3 Processing Paths	6
3.4 Channel screen, inputs and outputs	7
3.5 Hub DSP Receiver status LED behavior	7
3.6 Hub DSP Receiver Placement and Accessories	8
3.6.1 Hub Enclosure	8
3.6.2 Kensington Lock	8
3.6.3 Mounting Kit	8
4. Cube throwable microphone	9
4.1 Cube operating elements and connections	9
4.2 Cube Status LED behavior	9
4.3 Cube locking mechanism	10
4.4 Cube Charging	10
4.4.1 Powering the Charging Base	10
4.4.2 Charging the Cube mic	10
4.4.3 Basic Troubleshooting	11
4.5 Recommended distance	11

Table of Contents

5. Clip lavalier presenter microphone	12
5.1 Clip operating elements and connections	12
5.2 Clip status LED behavior	12
5.3 On/off switch and mute button	13
5.4 Clip charging	13
5.4.1 Powering the Charging Dock	13
5.4.2 Charging the Clip mic	13
5.5 Recommended Distance	14
6. Stick handheld microphone	15
6.1 Stick operating elements and connections	15
6.2 Stick LED behavior	15
6.3 On/off switch and mute button	16
6.3.1 Accessing the on/off switch	16
6.3.2 On off switch and mute button	16
6.4 Stick mic charging	16
6.4.1 Powering the Charging Dock	16
6.4.2 Charging the Stick mic	16
6.5 Recommended Distance	16
7. DECT wireless standard overview	17
7.1 Improving wireless signal strength	17
8. Maintenance, Storage, Disposal	18
8.1 Cleaning	18
8.1.1 General Cleaning instructions	18
8.1.2 Cube microphone	18
8.1.3 Clip microphone	18
8.1.4 Stick microphone	18
8.2 Storage	18
8.3 Disposal	18
9. Maintenance of Lithium-Ion Batteries	19
9.1 Follow these guidelines:	19
10. Certification	20

1. Safety instructions

1.1 Notice

- Before using the product, read and understand the user manual thoroughly. Ensure others who use the product are informed of its proper usage.
- Follow all warnings and instructions provided with the product and in this manual.
- Keep this user manual accessible and always include it when transferring the equipment to others.

1.2 Warning

- Not heeding these warnings may lead to serious injury or property damage.

1.2.1 Throwing the Cube mic

- Do not throw the Cube mic at peoples' heads. Ensure everyone is aware of the situation before throwing.
- Avoid using the Cube mic in areas with fragile objects, liquids, or around individuals susceptible to injury, such as young children or the elderly.
- Do not make long passes (over 5 m / 16 ft) or throw the Cube mic with excessive force.

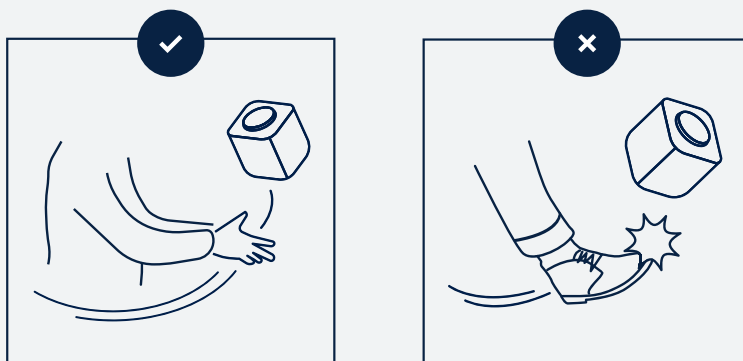

1.2.2 Proper Use

- Properly lock the Cube capsule into the Cover before use. Always use the cover and the foam cap on the Cube mic when using it.
- Avoid operating or storing the Cube mic at temperatures above 50°C / 122°F), as this can cause the locking mechanism to fail permanently.

1.2.3 Magnet precautions

- This product contains magnets that can affect pacemakers and other electronic implants. These devices may stop working or switch into test mode, causing illness. If you wear such devices, maintain a sufficient distance from the magnets.
- Warn others who wear electronic implants to keep a safe distance from the magnets.

1.3 Caution

- Magnets produce a far-reaching, strong magnetic field. Keep magnets away from devices and objects that could be damaged by strong magnetic fields, like laptops and other electrical equipment.
- Do not place any of the Catchbox mics near heat sources such as heating ducts or radiators. Avoid exposing them to direct sunlight, excessive dust, moisture, rain, mechanical vibrations, or shock.
- Do not use the equipment near water. Use it indoors only. If the equipment comes into contact with liquid, turn off the product, shut down the sound system, and disconnect the power cable from the power outlet immediately.
- Avoid excessive volume. Do not exceed 70dBa for airborne noise.
- Operate the equipment only with the included power supply.
- Clean the equipment with a moistened (not wet) cloth only. Ensure the equipment is disconnected from the power outlet before cleaning. Unplug the apparatus during lightning storms.
- Protect the power supply cord from being walked on or pinched.
- The equipment should be opened, serviced, and repaired by qualified personnel only.
- Do not attempt to modify this product or its accessories. Use only accessories and attachments, such as power supplies specified by the manufacturer.
- Changes or modifications to the equipment not expressly approved by the manufacturer can void the warranty and user's authority to operate the equipment.
- The Cube charging base and Clip, Stick mic charging docks use a strong electromagnetic field to operate. Keep the equipment away from metallic objects as they can heat up and cause injury or property damage.

2. System Products

2.1. Overview

The Catchbox Plus system is a wireless microphone solution for a variety of settings from simple hybrid meetings to complete multi-room installations. This system supports up to 4 channels per Hub DSP receiver, offering flexibility and performance for various audio capture needs. The components of the Plus system include the Cube throwable audience microphone, the Clip lavalier presenter microphone, the Stick handheld microphone, the Hub receiver with built in DSP, a charging base for the Cube and single or dual charging docks for the Clip and Stick microphones.

- Focused omni-directional™ microphones
- Operating range of 100 meters (330 feet) from the Hub
- DECT frequency for connectivity (1.8/1.9 GHz band)
- Serviceable batteries
- Out of range alarm to prevent loss or misplacement
- Dedicated chargers that also serve as Home stations, ensuring the pick-up-and-talk functionality
- Automatically muted, when on chargers
- Customizable covers and jackets for branding and personalization

3. Hub Receiver with built-in DSP

The Hub receiver with a built-in DSP is the central component of the Catchbox Plus system, designed for seamless connectivity and control of the wireless microphones. It is available with 2 or 4 channel microphone connectivity, each available with or without the Network.

The Hub features an integrated DSP with a mixer and audio processing capabilities, and offers a mixed output through a balanced 3-pin connector. It can mix and route audio signals from transmitters, USB sources, and AUX inputs to various outputs, potentially replacing a separate mixer and simplifying the setup process.

3.1 Connectivity Options

- **DANTE:** For advanced audio networking, providing separate unmixed channels and allowing for custom processing and mixing in an existing DSP.
- **3-pin Euroblock connectors:** provide separate unmixed channels, supporting individual channel processing.
- **USB:** Functions as an input, output, and power source, offering flexibility for audio connections.
- **Aux In:** an additional input option for external audio sources.

3.2 Hub DSP capabilities

The integrated DSP includes a mixer and advanced audio processing capabilities.

Mixed Output through a balanced 3-pin connector for reliable audio transmission to external audio systems. Ensures consistent audio output without the need for manual adjustments.

3.2.1 Automixer

1. Activates the microphone of the person currently speaking.
2. Quietly lowers the volume of other microphones to reduce background noise, echoes, and feedback.
3. Maintains a consistent overall sound level when multiple people are speaking simultaneously, preventing feedback.

3.2.2 Auto EQ and Auto Level

Auto EQ adjusts bass frequencies and balances sound levels based on the speaker's voice and microphone characteristics, ensuring clear audio and avoiding issues like boominess or nasal tones.

Auto Level adjusts the overall volume to ensure it is not too soft or loud for the far end, maintaining clear and consistent audio without the need for manual adjustments.

3.2.3 Echo Canceller and Howling Limiter

Echo Canceller gently lowers the volume of microphones when the far end is speaking and reduces incoming audio when someone at the near end (in the room) is talking. This prevents echoes and ensures clear two-way communication.

Howling Limiter protects against feedback by spotting and controlling the screeching noise that occurs when sound from a speaker re-enters the microphone.

3.2.4 Feedback Suppression

Further reduces feedback during voice-lift by slightly and continuously changing the pitch of the amplified sound and helping to prevent feedback.

3.3 Processing Paths

The Hub DSP Receiver supports two processing paths. Automixing is performed on all connected Catchbox microphones before splitting into these paths.

1. **Far-end/USB Audio path:** Available on USB output. Maintains clear, dynamic audio for remote participants, minimizing noise and peaks to prevent videoconferencing fatigue.
2. **In-room audio path:** Available on mixed 3-pin Euroblock, RCA, and DANTE output. Crucial for unattended spaces requiring voice-lift. It minimizes acoustic feedback risks caused by room imperfections or user error.

3.4 Channel screen, inputs and outputs

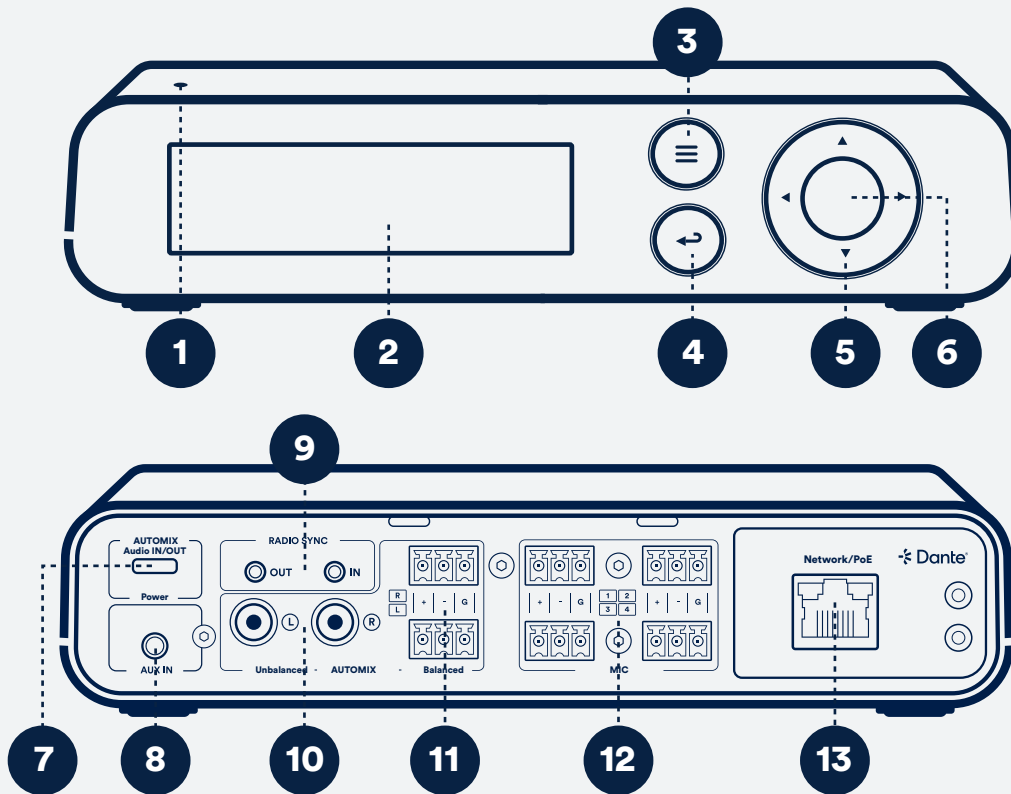

1. Status LED

2. Display

3. System menu

4. Back button

5. Navigation buttons

6. Press to open or to confirm

7. Automix Audio In/Out, Power, USB-C

8. AUX in 3.5mm

9. Radio sync In/Out

10. Automix - RCA, unbalanced, Line level

11. Automix - L&R, 3-pin, balanced, Mic level

12. Mic (1-4), 3-pin, balanced, Mic level

13. Network, PoE, Dante Audio in & out (4x4)

3.5 Hub DSP Receiver status LED behavior

Off Not powered

Green Power on, Transmitters paired to Hub

Orange Power on, No transmitters connected to Hub

Orange blinking In pairing mode

3.6 Hub DSP Receiver Placement and Accessories

3.6.1 Hub Enclosure

The Hub DSP Receiver is enclosed in a plastic body to ensure its internal antennas have optimal signal strength, avoiding the interference that metallic bodies can cause. Additionally, it includes ventilation holes on the sides.

3.6.2 Kensington Lock

To improve security, the Hub DSP Receiver includes a Kensington lock on its side. This allows the Hub to be securely locked in place, preventing theft or misplacement.

3.6.3 Mounting Kit

Mounting kit is an accessory specifically designed for the Hub. When the Hub DSP Receiver is placed in the Mounting Kit, it provides flexible installation options on walls, ceilings, the backs of TVs, or any other flat surfaces. The kit includes a cable management system to keep cables organized and protected.

When the Hub is mounted on a wall or ceiling, it functions as an access point, meaning it is in the line of sight of all transmitters in the room. This contrasts with rack or control room placement, where the radio signal might be weaker. In this scenario, the Hub is likely connected to the DANTE network and powered via PoE.

Another option is to attach the Hub to a TV screen or a mobile cart. Mounting Kit has a VESA mount standard, but it can also be attached to any surface using the Dual Lock fasteners that come in the package with the kit. This enables a simpler use case when TV serves as a screen for video conferencing, with the Hub connected to a computer running the video conferencing.

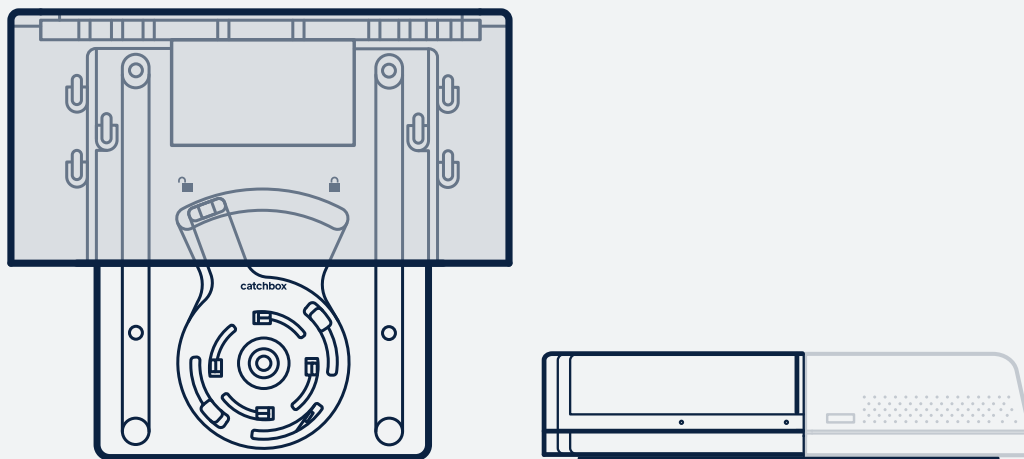

4. Cube throwable microphone

The Cube is a wireless throwable microphone for audio capturing and audience engagement. The Cube **battery life is 22 hrs** and it can be charged using the Charging Base.

If the Cube mic is taken out of the Hub DSP receiver's range, an automatic **Range Alarm** will go off and inform the user, encouraging them to bring the mic back to the designated room or event space.

The patented **Automute technology** ensures that no unwanted noise is picked up during motion. Its microphone capsule is located inside a soft cover that is treated with **antimicrobial ViralOff technology**.

The Cube is safe to throw, catch, and handle, making it ideal for conferences, classrooms, and corporate meetings.

4.1 Cube operating elements and connections

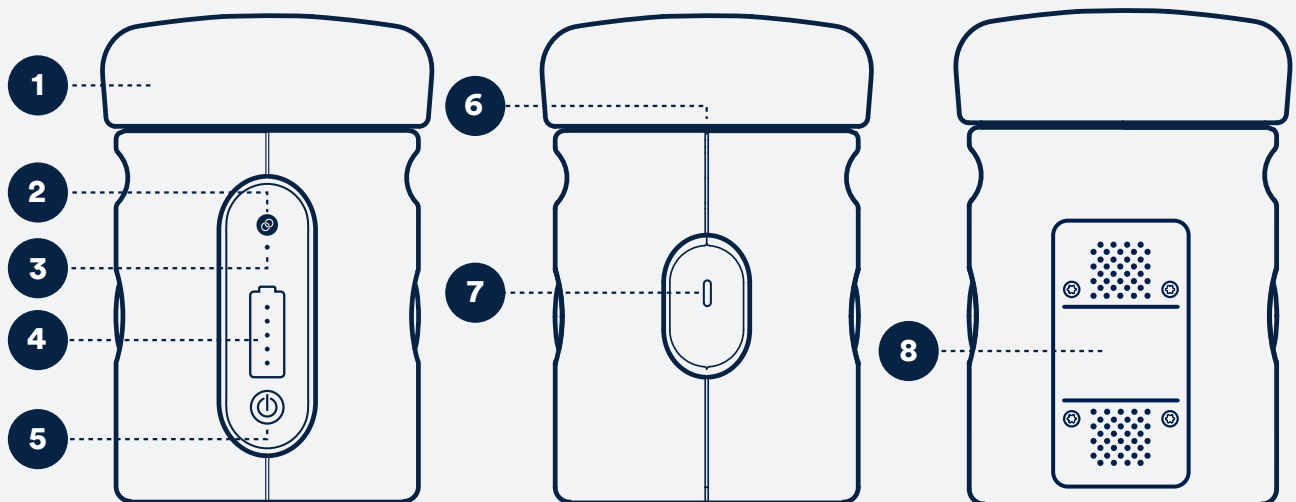

1. Foam cap

2. Pairing button - ong press to initiate pairing

3. Link LED

4. Battery status LED's

5. Power button - long press to turn the transmitter on/off, short press for Battery life

6. Microphone element

7. Power jack (USB-C)

8. Serviceable Battery compartment

4.2 Cube Status LED behavior

Off ● ● ● ● Not powered

Green ● ● ● ● Power on, Transmitters paired to Hub

Orange ● ● ● ● Power on, No transmitters connected to Hub

Orange blinking ● ● ● ● In pairing mode

4.3 Cube locking mechanism

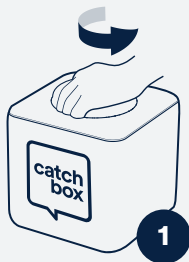

The capsule is held in place by magnets located on the bottom of both the cover and the capsule. To remove it, hold the capsule by the foam cap and turn it 90 degrees.

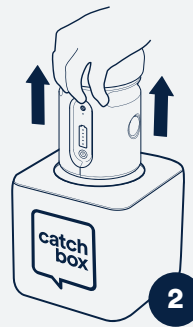

Once turned, you can pull the capsule out as the twist disengages the magnets.



When reinserting the capsule, align the triangles inside the cover with those on the bottom of the capsule.

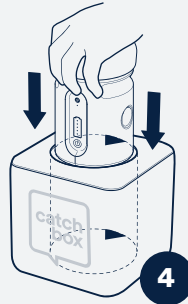

Place the capsule back in, ensuring the magnets are properly aligned.

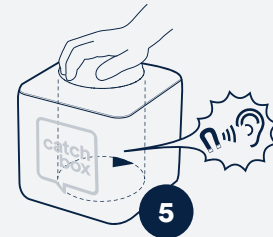

You'll hear a click sound, confirming the capsule is securely in place. To double-check, hold the Cube upside down. If the capsule stays put, it's secure.

4.4 Cube Charging

4.4.1 Powering the Charging Base

Cube mic should be charged on its dedicated charger - the Cube Charging Base.

1. Take the provided USB-C cable and plug it into the port located at the bottom of the Charging Base.
2. Arrange the cable within designated grooves to keep it organized and ensure it does not hang loosely or cause any obstruction.
3. Connect the other end of the cable to a power outlet.
4. When the Charging Base is powered, the middle one of the five LED indicators on the top part of the Charging Base will light up.

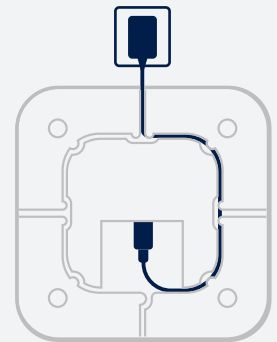

4.4.2 Charging the Cube mic

1. Always ensure the capsule is in the soft cover before placing the Cube mic on the Charging Base. The capsule alone will not charge.
2. Make sure the Cube is placed fully on the Charging Base. Improper placement can result in battery drainage rather than charging.
3. Ensure there are no foreign objects between the Cube and the Charging Base.
4. If all LED lights on the Charging Base are on, the Cube mic is fully charged.
5. If one of the lights is blinking, the Cube mic is not yet fully charged and is currently charging. A full charge takes 6 hours and the battery life on a full charge is 22 hours.
6. The Cube mic is automatically muted when on the Charging Base.

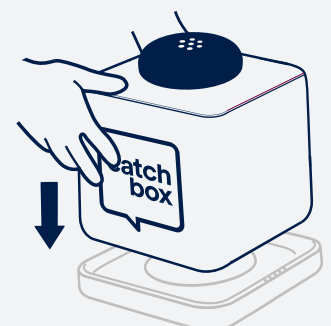

4.4.3 Basic Troubleshooting

- If the Cube mic's battery is critically low, you may need to charge it with a USB-C cable first.
 - Remove the capsule from the soft cover by twisting and pulling it out.
 - Connect the USB-C cable to the capsule and let it charge for at least 1-2 hours.
 - Once charged, place the capsule back into the soft cover and put the Cube mic on the charging base. Check if the LED lights behave normally.
- If all LED status lights are blinking, the Cube may be overheating.
 - Remove the capsule from the soft cover and let it cool down.
 - Ensure the room temperature is below 30°C / 86°F.

4.5 Recommended distance

To use the Cube mic, simply speak into the foam cap located on top of the transmitter. The recommended distance between the speaker and the Cube mic is around 20 cm / 8 in. However, the Cube will provide clear sound even if this distance is not strictly maintained.



5. Clip lavalier presenter microphone

Clip is a wearable presenter microphone designed for ease of use and high audio quality. It has an **8-hour battery life** and the Clip mic is compatible with both Single and Dual Charging Docks that can be daisy-chained, optimizing the use of power outlets.

If the Clip mic is taken out of the Hub DSP receiver's range, an automatic **Range Alarm** will go off and inform the user, encouraging them to bring the mic back to the designated room or event space.

Clip mic has **only 2 buttons**: the on/off switch, which is hidden under the Clip lever, and the Mute button.

The Clip **unmutes automatically** when picked up from the charging dock.

It can be clipped onto clothing or worn around the neck with the **provided lanyard**.

Clip mic captures clear audio regardless of head movement, ensuring that every word is heard clearly.

5.1 Clip operating elements and connections

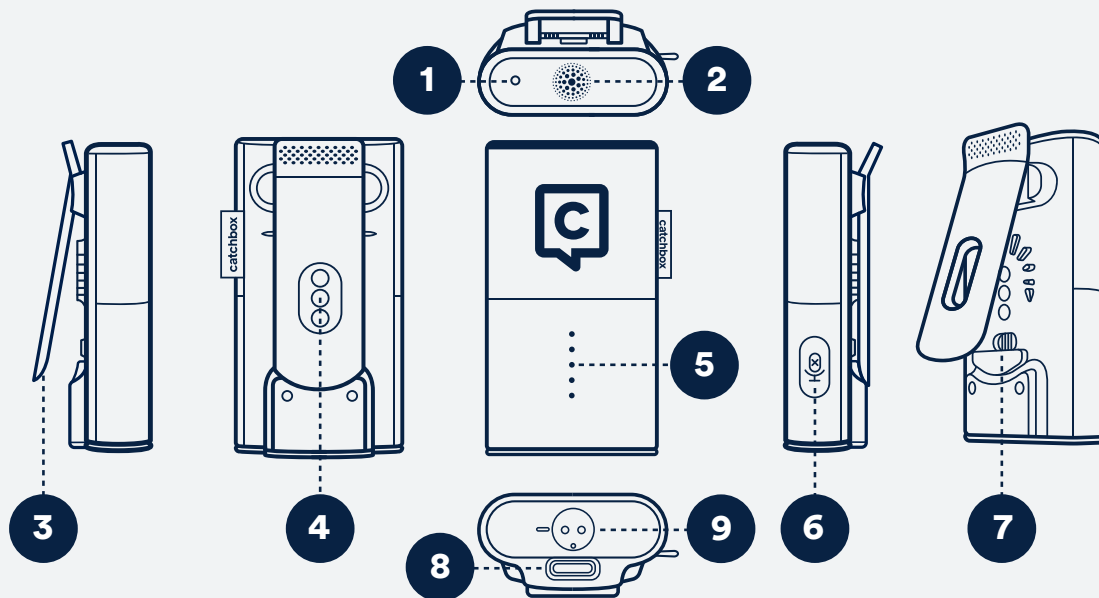

1. Status LED

6. Mute button

a. If Mute button is pressed for 10 sec, pairing is initiated

2. Microphone element

7. Power switch

3. Clip

8. Power jack (USB-C)

4. Charging pads

9. Serviceable battery compartment

5. Battery LED's

5.2 Clip status LED behavior

Off ●●●● Not powered

Green ●●●● Power on, Transmitters paired to Hub

Orange ●●●● Power on, No transmitters connected to Hub

Orange blinking ●●●● In pairing mode

5.3 On/off switch and mute button



- Open the Clip lever to turn the power switch on or off.
- Press the mute button to control the microphone: if the symbol is red, the Clip is muted; if the symbol is white, the mic is unmuted.
- While on the charging dock, the Clip is automatically muted.
- The mic turns on and unmutes automatically when picked up from the charging dock, allowing for immediate use.

5.4 Clip charging

5.4.1 Powering the Charging Dock

The Clip mic should be charged on its dedicated charger - the Charging Dock.

1. Take the provided USB-C cable and plug it into the port located at the bottom of the Charging Dock.
2. Arrange the cable within the designated grooves to keep it organized and ensure it does not hang loosely or cause any obstruction.
3. Connect the other end of the cable to a power outlet.
4. When the Charging Dock is powered, the LED light on the top part of the Dock will light up.

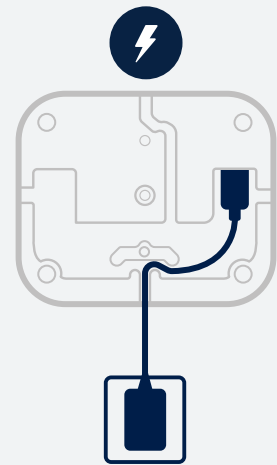

5.4.2. Charging the Clip mic

1. Place the Clip mic on the Charging Dock. Magnetic pins will help ensure the Clip is positioned.
2. If all LED lights on the front of the Clip are on, the mic is fully charged.
3. If one of the lights is blinking, the Clip mic is not yet fully charged and is currently charging. A full charge takes 2 hours and the battery life on a full charge is up to 8 hours.
4. The Clip mic is automatically muted while charging.

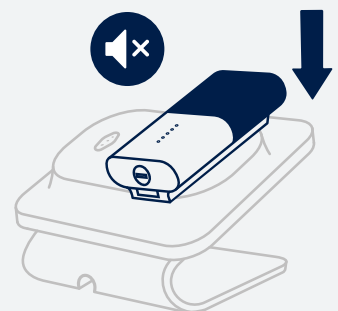

5.5 Recommended Distance

The Clip mic can be either clipped onto clothing or worn around the neck using the provided lanyard.

The recommended distance between the mic and the speaker is 20 cm/8 in and wearing the Clip mic with a lanyard will naturally provide that.

With the advanced audio processing functionalities, the Clip maintains great audio quality even when the recommended distance isn't strictly maintained or when presenters move their heads.

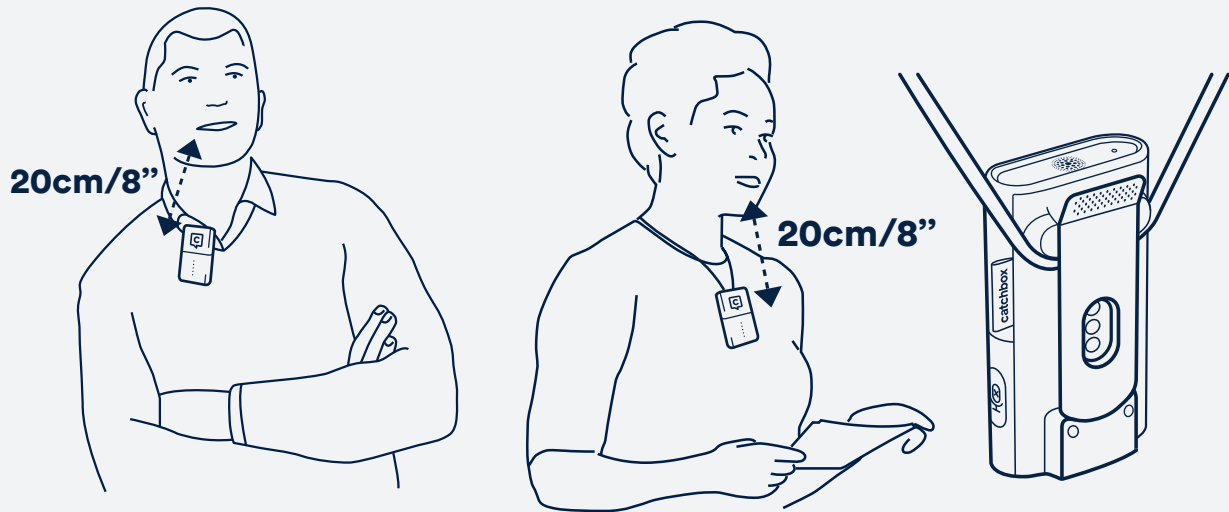

6. Stick handheld microphone

The Stick is a handheld presenter microphone.

Featuring a built-in pop filter, it **reduces disruptive sounds**, ensuring clear and professional audio quality.

It has an **8-hour battery life** and the Stick mic is compatible with both Single and Dual Charging Docks that can be daisy-chained, optimizing the use of power outlets.

If the Stick mic is taken out of the Hub DSP receiver's range, an automatic **Range Alarm** will go off and inform the user, encouraging them to bring the mic back to the designated room or event space. The Stick microphone **activates and unmutes automatically** when picked up from its Charging Dock. Its ergonomic design provides a comfortable grip, ideal for presentations and speeches.

6.1 Stick operating elements and connections

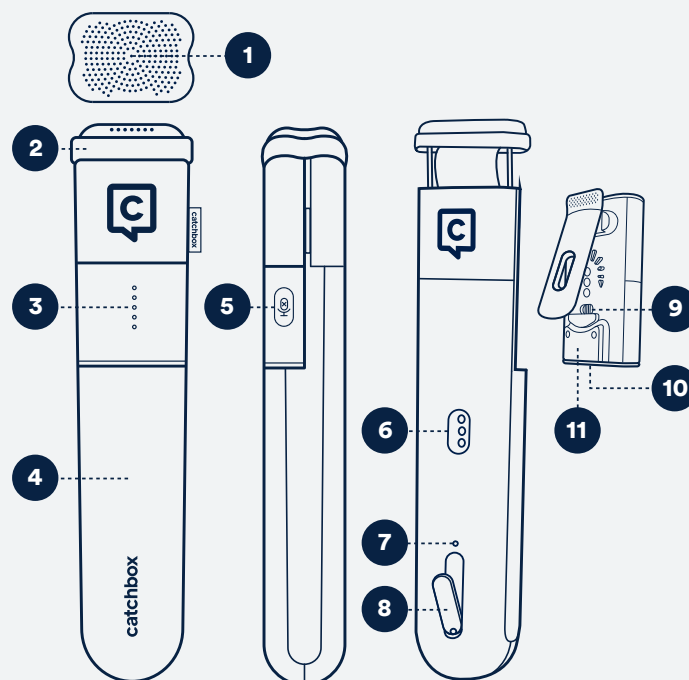

1. Pop filter

2. Microphone element

3. Battery LED

4. Adapter

5. Mute button

a. If Mute button is pressed for 10 sec, pairing is initiated

6. Charging pads

7. Status LED

8. Lever

9. Power switch

10. Power jack (USB-C)

11. Serviceable battery compartment

6.2 Stick LED behavior

Off Not powered

Green Power on, Transmitters paired to Hub

Orange Power on, No transmitters connected to Hub

Orange blinking In pairing mode

6.3 On/off switch and mute button

6.3.1 Accessing the on/off switch

1. Push the bottom part of the lever on the back of the Stick mic. This will lift the upper part of the Stick mic and release the Clip.
2. Open the Clip lever to access and turn the power switch on or off.

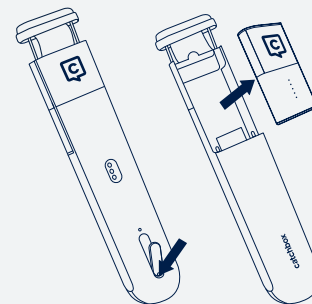

6.3.2 On/off switch and mute button

- Press the mute button to control the microphone: if the symbol is red, the Stick is muted; if the symbol is white, the mic is unmuted.
- While on the charging dock, the Stick mic is automatically muted.
- The mic turns on and unmutes automatically when picked up from the charging dock, allowing for immediate use.

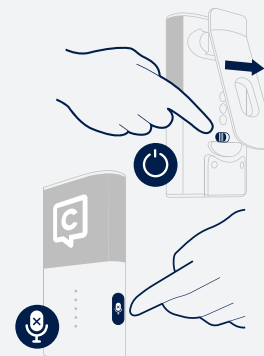

6.4 Stick mic charging

The Stick mic should be charged on its dedicated charger - the Charging Dock.

1. Take the provided USB-C cable and plug it into the port located at the bottom of the Charging Dock.
2. Arrange the cable within the designated grooves to keep it organized and ensure it does not hang loosely or cause any obstruction.
3. Connect the other end of the cable to a power outlet.
4. When the Charging Dock is powered, the LED light on the top part of the Dock will light up.

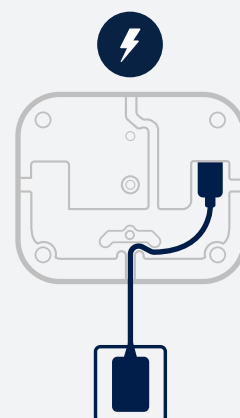

6.4.2 Charging the Stick mic

5.4.1 Powering the Charging Dock

1. Place the Stick mic on the Charging Dock. Magnetic pins will help ensure the Stick is positioned correctly.
2. If all LED lights on the front of the Stick are on, the mic is fully charged.
3. If one of the lights is blinking, the Stick mic is not yet fully charged and is currently charging. A full charge takes 2 hours and the battery life on a full charge is up to 8 hours.
4. The Stick mic is automatically muted while charging.

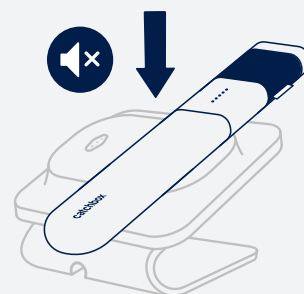

6.5 Recommended Distance

When using the Stick mic, hold it about 10 cm/ 4 in away from your mouth. Thanks to our advanced audio processing functionalities, the Stick mic maintains excellent sound quality even if this distance is not strictly maintained or if the presenter moves while speaking.

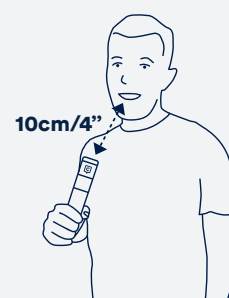

7. DECT wireless standard overview

DECT stands for Digital Enhanced Cordless Telecommunications. The DECT standard uses a distributed Dynamic Channel Allocation (DCA) algorithm to automatically and dynamically select the transmission frequency from the designated frequency band during product use. This feature helps to avoid potential interference with other DECT-enabled devices. However, other DECT-enabled devices such as cordless phones or translation systems may cause interference if used close to the Catchbox Plus system.

The wireless range of Catchbox Plus microphones is 100 m / 330 ft under ideal conditions (line of sight). However, indoor obstacles like walls, furniture, and people may reduce the effective range.

DECT standard frequency bands:

- 1880 to 1900 Hz in Europe.
- 1920 to 1930 Hz (DECT 6.0) in the United States and Canada.
- 1893 to 1906 Hz (J-DECT) in Japan.

Other regions may use different spectrum allocations.

Please check the actual frequency band with your local authority.

7.1 Improving wireless signal strength

To improve the performance of your Catchbox Plus system, consider the following measures:

- Ensure there are no objects or walls between any Catchbox Plus microphones and the Hub DSP Receiver.
- Decrease the distance between the microphones and the Hub DSP Receiver
- Keep the microphones and the Hub DSP Receiver in the same room.
- Avoid placing the Hub DSP Receiver in a closed area, such as inside a shelf or a rack (especially metallic).

8. Maintenance, Storage, Disposal

Proper maintenance and storage of the Catchbox Plus wireless system are essential to ensure the product remains operational and safe to use. Improper maintenance or storage can lead to equipment failure, which may cause serious injury during use. Always refer to this user manual for proper maintenance, storage, and disposal instructions. Keep this manual near the product for easy reference by all users.

8.1 Cleaning

Proper cleaning of the Catchbox Plus system helps maintain its functionality and longevity. Follow these instructions to clean the Cube, Clip, and Stick microphones safely:

8.1.1 General Cleaning instructions

- Before cleaning, ensure the microphones are removed from their chargers and are not connected to any cables, such as USB-C.
- Use a moistened (not wet) cloth to clean the equipment.
- Do not use harsh chemicals or abrasive materials to clean any part of the system.

8.1.2 Cube microphone

- Remove the mic capsule from inside the Cube cover by twisting and pulling it out to release it from the magnets.
- Have the Cube cover cleaned by a professional dry cleaner. Do not place the cover in a washing machine.
- Inform cleaners that the cover contains a magnet and should not be treated in temperatures exceeding 50°C / 122°F or near equipment sensitive to strong magnetic fields.
- Note that Cube cover is treated with ViralOff® technology, which can reduce the need of frequent washing.

8.1.3 Clip microphone

- Detach the Clip microphone from any attached clothing or accessories.
- Wipe the Clip microphone with slightly moistened cloth.
- Ensure the microphone is completely dry before reattaching it to clothing or accessories.

8.1.4 Stick microphone

- Wipe the microphone handle and the top part with a moistened cloth.
- Avoid excessive moisture around the microphone top part to prevent damage.

8.2 Storage

Proper storage of the Catchbox Plus system is essential for maintaining its performance. Always refer to this user manual for proper storage instructions and keep it accessible for reference by other users.

- The microphones contain strong magnets. Keep them away from devices and objects that could be damaged by strong magnetic fields, such as laptops and other electronic equipment.
- Store the microphones and other components in temperatures between 0 to 50°C (32 to 122°F). Exposure to temperatures above this range can cause the locking mechanism for the Cube capsule to fail, which may result in the capsule falling out and potentially causing injury or damage.
- Avoid placing the equipment near heat sources like heating ducts or radiators. Do not expose the Plus system components to direct sunlight, excessive dust, moisture, rain, mechanical vibrations, or shock.
- Do not use or store the microphones near water. If any part of the equipment comes into contact with a liquid, disconnect any connected cables immediately.

8.3 Disposal

For disposal of broken or defective units, please return the unit to the manufacturer or consult your local waste management professionals for proper methods.

9. Maintenance of Lithium-Ion Batteries

The Catchbox Plus system utilizes rechargeable lithium-ion batteries for all three microphone types: Cube throwable, Clip presenter mic, and Stick handheld presenter mic. Proper maintenance and handling of these batteries are essential for safe operation.

9.1 Follow these guidelines:

- The batteries in all three microphone transmitters are serviceable, meaning Catchbox will replace the batteries once they are no longer functional.
- Do not damage or pierce the batteries. Damaged batteries can accumulate hazardous gasses,
- Do not expose the product or batteries to water or fire.
- Always follow the provided instructions for charging the microphones.
- Use only original chargers provided with the Catchbox Plus system.
- Operate and store the product in temperatures between 0 to 30°C (32 to 86°F).
- Rechargeable lithium-ion batteries will gradually
- The typical estimated lifespan of a lithium-ion battery
- Do not leave the batteries unused for extended periods. Charge the batteries every 6 months.
- For long-term storage, charge the batteries to approximately 50% capacity.
- To dispose of old batteries, consult your local waste management professional for proper disposal methods.

10. Certification

Catchbox Plus system consists of:

Catchbox Plus Cube (Model #:CBPLTX003)
Catchbox Plus Clip (Model #: CBPLCL002)
Catchbox Plus Stick (Model #:CBPLST001)
Catchbox Plus Hub (Model #:CBPLRX003)
Charging Base (Model #:CBWCH002)
Single Charging Dock (Model #:CBDC001)



Certified under FCC CFR 47 Part 15 Subpart D.

FCC ID: 2AP8U-CBDECTRF001

Certified under IC in Canada under ISED RSS-213 Issue 3, ISED RSS-GEN Issue 4.

IC ID: 24039-CBDECTRF001.

Products that contain a pre-certified DECT module and meet the essential requirements of the European RED directive 2014/53/EU are:

Catchbox Plus Cube (Model #:CBPLTX003),
Catchbox Plus Clip (Model #: CBPLCL002),
Catchbox Plus Stick (Model #:CBPLST001),
Catchbox Plus Hub (Model #:CBPLRX003).

These 4 products also comply with the following standards:

- EN 301 406 V2.2.2
- EN 55032:2015 & EN 55035:2017
- EN 301 489-3 V2.1.1 & ETSI EN 301 489-6 V2.2.0 (ETSI EN 301 489-1 V2.1.1)

Charging Base (Model #: CBWCH0002)

Product meets the essential requirements of the European RED directive 2014/53/EU and is found to comply with the following standards:

- EN 303 417 V1.1.1
- EN 55032:2015 & EN 55035:2017

Certified under FCC CFR 47 Part 15 Subpart D.

FCC ID: 2AP8U-CBDECTRF001

Certified under IC in Canada under ISED RSS-213 Issue 3, ISED RSS-GEN Issue 4.

IC: 24039-CBDECTRF001

Designed and made in the EU.

Explore Knowledge base or contact Support team

For more information contact the Support team at info@catchbox.com

or explore the full Knowledge base: help.catchbox.com/knowledge

